

**TOWFLEX**
Aircraft Tugs

TF5.5 AIRCRAFT TUG
MANUAL



VERSION 5.5-21-07-1

WHAT'S IN YOUR HANGAR?



INDEX

TABLE OF CONTENT

1. INTRODUCTION

1.1	Your Aircraft Tug	6
1.2	Notes for the Operating instructions	6
1.3	Target group and prior knowledge	6
1.4	Scope of Delivery	7
1.5	Use of Symbols in Safety Instructions	7
1.6	Safety	8
1.6.1	General Safety	8
1.6.2	Important service note	9
1.7	Storage of the operating instructions	9
1.8	Copyright	9

2. RISK AND SECURITY STATEMENTS

2.1	Intended Use	10
2.2	Use under extreme conditions	10
2.3	Danger zone	10
2.4	Ramps, Slopes and Inclines	11
2.5	Routes and Parking	11
2.6	Obligations Of Operator	11
2.7	Attachments or additional equipment	12
2.8	Improper Use	12
2.9	Residual risks even with correct instruction	12
2.10	Protective Measures	13
2.11	Driving permit	13
2.12	Rights, obligations and rules of conduct	13
2.13	Prohibition of use by unauthorized persons	13
2.14	Damage and Defects	13
2.15	Repairs and Maintenance	14
2.16	Persons at Risk	14
2.17	Fire protection	14



3. VEHICLE DESCRIPTION

3.1	Application	15
3.2	Assemblies and Functions	15
3.3	General Vehicle Description	16
3.4	Drive	16
3.5	Lighting	16
3.6	Brake	16
3.7	Nose Gear Cradle and Lifting platform	17
3.8	e-Cube	17
3.9	Control statement	18
3.10	Warnings and Typeplates	18
3.11	EC-Declaration of Conformity	20
3.12	More Certifications	21
3.13	Specifications	22
3.14	Remote Control	23
3.15	Power supply	23
3.16	Connections	23
3.17	Supplies	24
3.18	Ambient Temperature & Working environment	24
3.19	Pollution of the environment and surrounding personnel	24

4. OPERATION AND USE

4.1	Remote control	25
4.2	Turning the Remote Control On and Off	27
4.3	Battery Charger and Battery of the Remote Control	27
4.4	Battery Removal of the Remote Control	27
4.5	Manual Channel change	28
4.6	Safety Mode / Dead-Man-Mode	28
4.7	Turntable Gate and Lock	28
4.8	Aircraft tug charger	29
4.9	Direction Indicators	30
4.10	Status-LED	30
4.11	MDI Display	30

5. TOWFLEXX OPERATION

5.1	Switching the Aircraft Tug on and off	31
5.2	Battery Disconnect Switch Activation (e-Stop)	32
5.3	Release Battery Disconnect Switch	32
5.4	Tests and Activities before daily Startup	32
5.5	Set Nose Wheel Adapter	33
5.6	Capturing the Aircraft	33
5.7	Aircraft Release	36
5.8	Turntable Motor	37
5.9	Nosewheel Approach Configurations	38
5.10	Towing Ground Support Equipment	38
5.11	Emergency Release of the Winch	39
5.12	Releasing the Magnetic Brake	40

6. MAINTENANCE

6.1	Maintenance Schedule	41
6.2	Plan of Fuses	42

7. REPAIR AND OVERHAUL

7.1	General Information	44
7.2	Requirements for the Storage Room	44
7.3	Actions before and during Shut Down	44
7.4	Required Actions during Decommissioning	44
7.5	Re-commissioning the Aircraft Tug	44
7.6	Work on the Electronics	45
7.7	Battery Replacement	45
7.8	e-Cube Replacement	46
7.9	Turntable Gate Realignment	46
7.10	Steel Cable Realignment	48



8. PACKAGING AND TRANSPORT

- 8.1 Unloading the Aircraft Tug 49
- 8.2 Transport Without Crate 52

9. DISPOSAL

52

10. APPENDIX

- 10.1 Error Codes 53

11. TRAINING CERTIFICATE

55

1. INTRODUCTION

1.1 YOUR AIRCRAFT TUG

The TowFLEXX TF5 has been in development for a long time and offers the best in security, ease and comfort when towing an aircraft. It is in your hands to preserve these features and to take advantage of the resulting benefits.

These instructions show everything you need to know about commissioning, maintenance and towing with the TowFLEXX TF5. The inspection and maintenance work must be carried out regularly and with the required operating supplies and tools. For non-described maintenance and repair work, expertise, special tools and measuring instruments are required. For this contact your dealer or the manufacturer. Maintenance may only be carried out by qualified and officially TowFLEXX certified personnel.

1.2 NOTES FOR THE OPERATING INSTRUCTIONS

TowFLEXX endeavour to make operating manual and the tug user friendly with step by step clear instructions with all chapters and page numbers marked for ease of reference on how to commission, operate and maintain the tug within the manual.

Reading these instructions will give basics overview of how the tug operates, however mandatory training is still required for driving permits.



The manufacturer reserves the right to make changes and/or improvements in designs and demensions without notice and without incurring obligation.

1.3 TARGET GROUP AND PRIOR KNOWLEDGE

These operating instructions are intended for all persons who are involved in the work process for towing aircraft, as well as helicopters with the described aircraft tug. This includes the following groups of people:

- End Customer, User
- Maintenance Personnel of the Aircraft Tug
- Dealer



It is highly recommended to attend a certified product training to understand all operating procedures described in this manual. Please read and understand this manual.

1.4 SCOPE OF DELIVERY

Generally included in delivery:

- TowFLEXX TF5 Aircraft tug
- Remote Control
- Integrated Charger
- Operating Manual
- Optional ordered Accessories/Attachments

1.5 USE OF SYMBOLS IN SAFETY INSTRUCTIONS

These operating instructions contain safety instructions with symbols which point out possible dangers or residual dangers. These safety instructions and symbols have the following meaning:



Risk: This safety note indicates the imminent danger to the life and health of persons! Failure to comply with these instructions can result in a health risk for life-threatening injuries and property damage



Attention: This safety instruction indicates possible dangers due to electric shock! Failure to comply with these instructions can lead to a health risk with life-threatening injuries, property- and equipment damage.



Danger: This safety note indicates possible danger of crushing, which exists in exceptional cases. Failure to comply with these instructions can result in a health risk for life-threatening injuries and property damage



Note: Note the Obligation to Read the Operating instructions!

1.6 SAFETY

This operating manual contains safety instructions which draw attention to possible dangers and thus enable the safe operation of the electric aircraft tug. Please pay attention to these safety instructions!

This section contains general safety instructions that are not related to regular operation. Special information can be found in the specific sections.

1.6.1 GENERAL SAFETY



Before putting the aircraft tug into operation, read the operating instructions and make them available to other users!



Under no circumstances should one open the engine control or other covers! There is a risk of electric shock.



The motor control system may only be operated with the 24V DC rated voltage specified on the nameplate!



It should always be noted that no connections or switches are damaged. Operating the aircraft tug with damaged components is prohibited!



In the event of a malfunction (e.g. if the engine control system continues to move independently when the direction button is fixed), immediately actuate the emergency stop switch on the radio remote control or one of the two battery disconnection switches on the aircraft tug!



All electrical components must be protected against moisture, dripping and splashing water! Submersion of the unit will void all warranties.



The electric aircraft tug must not be operated in any possibly explosive environments, unless it has a special configuration and certification!



There is a risk of crushing when towing any aircraft. It is essential to ensure that there are no objects or persons in the danger area.



Modifications or changes to the unit are prohibited and will void the warranty.

1.6.2 IMPORTANT SERVICE NOTE



Only OEM accessories are approved! These may only be installed by qualified and officially TowFLEXX certified personnel! The use of non-OEM accessories voids the warranty!



The user may only replace cables with OEM cable assemblies. Further changes must be carried out by authorized, factory trained companies.

1.7 STORAGE OF THE OPERATING INSTRUCTIONS

These operating instructions remain in the aircraft tug. The storage is located in the front part of the tug under the cover, in the storage box provided for this purpose. If instructions are damaged or unreadable reprint before using equipment.





Storage box for the Operating Instructions



1.8 COPYRIGHT

TowFLEXX GmbH
Woestendoellen 95-96
49429 Visbek
Germany

 +49 4445 988-144
 help@towflexx.com

2. RISK AND SECURITY STATEMENTS

2.1 INTENDED USE

The aircraft tug may only be used as intended. It serves to lift and move aircrafts by cradling the nose wheel. It is important to pay attention to the carrying capacity (max load). Possible aerospace ground equipment can be towed when authorized with appropriate OEM equipment.

Damaged or defective tugs may not be operated until they have been properly repaired. Safety switches, straps and safety devices must not be removed or bypassed. Specified settings may not be changed without the manufacturer's consent. Damage to aircraft, personal injury or death may occur.

2.2 USE UNDER EXTREME CONDITIONS

Using the aircraft tug under extreme conditions can cause malfunction and accidents. Please pay attention to the specified operating conditions (3.13.)

- For operations in extreme conditions, especially in heavily dusty or corrosive environments, the aircraft tow tug requires special equipment and approval.
- Use in potentially explosive environments is not permitted unless the aircraft tug has the appropriate certification.
- In the event of (electrical) storms the aircraft tow tractor may not be operated outdoors or in hazardous areas. Particular attention must be paid to the maximum crosswind component of the towed aircraft. Excessive crosswinds can lead to loss of traction control of the tug. Ensure applicable technical data is understood and followed.

2.3 DANGER ZONE

A hazardous area is defined as the area in which persons are endangered by movements of the tug with and without the aircraft in-tow. No persons may be present in the danger area of the tug. The manufacturer recommends a safety distance of at least 2 meters (6 feet 7 inches). In addition, the user must always have his surroundings in view and look for other possible sources of danger.



WARNING: Risk of accident / injury when in the danger zone of the aircraft tug.

2.4 RAMPS, SLOPES AND INCLINES

All ramps, slopes or inclines must not exceed more than 1% as stated on the warning stickers on the tug. Extended stopping distances due to loss of traction could be a direct result from smooth surface slopes or inclines and potential damage to tug or aircraft

Full traction can only be achieved on a flat surface. The higher the incline, the weaker the traction. If the tug is operated continuously (for more than five minutes) on a slope, it may cause the main fuse to blow. This protects the electronics and does not damage the device.

The tug should not be operated in case of a too steep down grade, because under certain circumstances the braking force of the motors may not be sufficient anymore.



ATTENTION! If the maximum values for incline and decline are ignored, there is danger to life. Your aircraft and tug could be damaged! Maximum towing capacity can only be granted on flat surfaces.

The EU Directive 89/654/EEC (Minimum Requirements for Safety and Health at Work) in its current version must be complied with. For countries outside the EU, the national regulations apply.

2.5 ROUTES AND PARKING

Routes must be adequately, flat and free of objects. The paths must be clearly visible to the operator. Attention must be paid to protruding hangar rails drainage channels. The permissible area and point loads must not be exceeded.

2.6 OBLIGATIONS OF OPERATOR

Operator in the sense of these operating instructions is any natural or legal person who uses the aircraft tug or on whose behalf it is used. In special cases (eg leasing, rental), the operator is the person who, in accordance with the existing contractual agreements between the owner and the operator of the aircraft tug, has to fulfill the stated operational obligations.

The operator must ensure that the aircraft tug is only used as intended and that all types of dangers to the life and health of the operator or third parties are avoided. In addition, attention must be paid to compliance with accident prevention regulations, other safety regulations, as well as the operating, maintenance and repair guidelines. The operator must ensure that all operators have read and understood this operating manual.



Failure to comply with this manual will void the warranty. The same applies if the customer and / or third parties have performed improper work on the tug without the manufacturer's consent.

2.7 ATTACHMENTS OR ADDITIONAL EQUIPMENT

The installation of additional equipment to interfere in the function of the aircraft tug or to supplement its functions shall be permitted only with the written consent of the manufacturer. If necessary, obtain TF5 instruction manual from your dealer. However, the approval of the dealer does not replace the approval of the manufacturer.

2.8 IMPROPER USE

Any use for which the tug is not approved is the responsibility of the operator or driver and not the manufacturer. The following list is only an example and does not claim to be exhaustive. The tugs not approved for:

- Riding on the tug unless the tug is specially equipped for this purpose
- Use in fire or explosion-hazard areas unless it has special certification for this
- Exceeding the maximum capacity
- Exceeding the restricted speed at max towing



DANGER: Improper use can result in serious injuries or even death.

2.9 RESIDUAL RISKS EVEN WITH CORRECT INSTRUCTION

Despite observance of all listed safety, certain residual risks can not be excluded. When operating the aircraft tug, maximum attention must be paid to the tug, environment and aircraft.



2.10 PROTECTIVE MEASURES

In order to prevent injuries, the operator must be equipped with sufficient protective clothing. In general, the operator must wear safety shoes when towing. If you are working on the apron in low light / no light condition you must also provide safety vests for every person involved in the operation. Please adhere to your own risk assessment on PPE whilst operating on the apron.

If the above protective measures are not provided by the operator, the operator must refrain from operating the aircraft tug.

2.11 DRIVING PERMIT

The aircraft tug may not be used to reposition aircraft until the mandatory training by official TowFLEXX personnel has been completed. This training takes place either on site or online if requested. Failure to comply with this regulation may void the manufacturer's warranty. If necessary, the national regulations must be observed.



The manufacturer strongly recommends product training for all operators. Alternatively, a train the trainer program is available. For further questions please contact your dealer or the manufacturer.

2.12 RIGHTS, OBLIGATIONS AND RULES OF CONDUCT

The operator must be informed about his rights and obligations, instructed in the operation of the aircraft tow tug and familiarized with the contents of this operating manual.

2.13 PROHIBITION OF USE BY UNAUTHORIZED PERSONS

The operator is responsible for the aircraft tug during the period of use. The operator must forbid unauthorized persons to drive or operate the tug. No persons are allowed to be transported on the TowFLEXX equipment.

2.14 DAMAGE AND DEFECTS

Damage or other defects to the aircraft tug or supporting equipment must be reported immediately for assessment. For defect please seek help from the TowFLEXX technical department prior to attempting to repair.

2.15 REPAIRS AND MAINTENANCE

The operator may not carry out any repairs or modifications to the aircraft tug without permission and without special training by officially authorised personnel, unless otherwise agreed in writing. If agreed in writing, the manufacturer will provide detailed instructions to carry out the specific actions required.

Under no circumstances may the operator deactivate or remove safety devices or switches.

2.16 PERSONS AT RISK

All personnel operating the TowFLEX tug must have received adequate and comprehensive training. Operating under the influence of alcohol, drugs or other substances that impair the ability to perceive is strictly prohibited!

2.17 FIRE PROTECTION

At no time may escape routes or other fire protection equipment be blocked by the aircraft tug or its attachments or accessories. Dangerous areas must not be passed over and must be avoided with sufficient clearance.

Please observe the local fire safety precautions and risk assessments. This also applies to the storage of flammable or combustible materials when the tug is charging. The room should be ventilated sufficiently and appropriate fire extinguishers should be available.



The TF5 is equipped with the latest smart safe battery charger and can be charged by simply plugging the charger into a wall plug socket.



Risk of chemical burns due to the use of unsuitable fire-retardants In case of fire, a reaction with the battery acid can occur when extinguishing with water. This can lead to acid burns.

- ***Use a CO2 / suitable extinguisher.***
- ***Never extinguish burning batteries with water.***

3. VEHICLE DESCRIPTION

3.1 APPLICATION

The TowFLEXX TF5 is a purely electric, towbar-less aircraft tug intended for towing and maneuvering general aviation aircraft and aerospace ground equipment when properly equipped with OEM accessories.

The aircraft tug can be operated both in the hangar and on the apron and allows several towing operations per day, depending on the load without intermediate charge. Weight restrictions and take-up loads can be found on the dataplate.

3.2 ASSEMBLIES AND FUNCTIONS

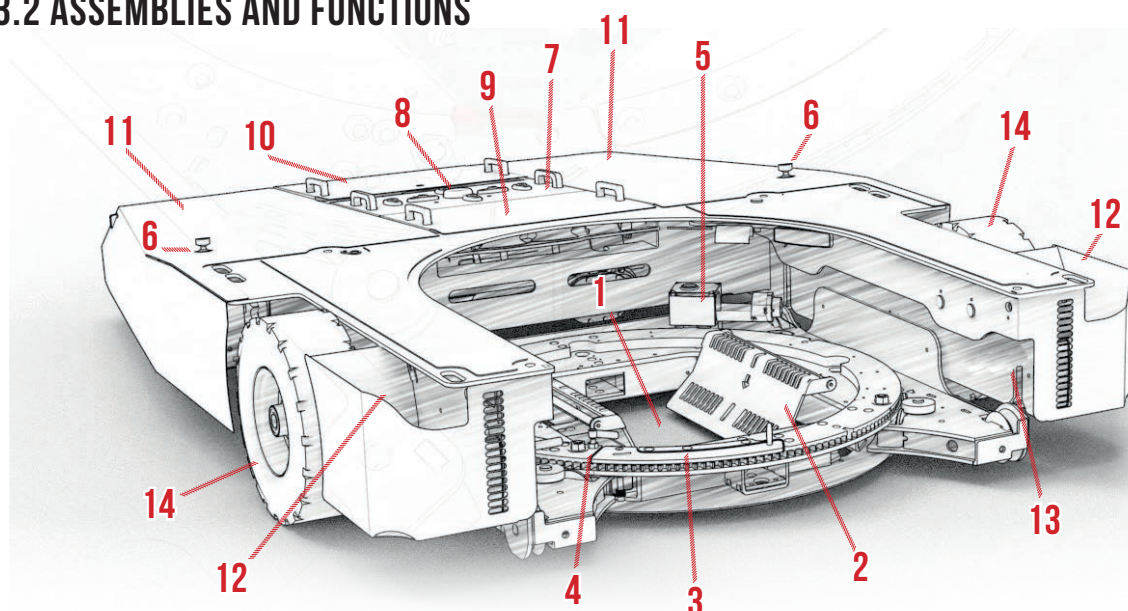

1	Lifting Platform
2	Nosewheel Adapter
3	Turntable Gate
4	Turntable Gate Lock
5	Turntable Motor
6	Battery Disconnect Switch (eStop)
7	e-Cube (Control Center of the Tug)
8	Direction- & Status-LEDs
9	Steel Cable Winch
10	Front Compartment (incl. Charger & Manual)
11	Side Cover (underneath: Batteries)
12	Compartments
13	Lifting Platform Steel Cable Suspension
14	Drive Wheels (Solid Rubber)

3.3 GENERAL VEHICLE DESCRIPTION

The aircraft tug frame is made of steel and is galvanized, thus completely weatherproof. Two individually driven solid rubber tires together with the heavy-duty fixed castors make the aircraft tug extremely maneuverable so that it can be rotated 360 degrees on the spot without restrictions.

The charger, operating instructions and multifunctional display (MDI) can be accessed via the front storage compartment. In addition, there are two storage compartments at the side of the aircraft tug. All functions of the tug are electronic, mechanical and electromechanical. Thus, the aircraft tug is completely free of hydraulics.

3.4 DRIVE

The drive is provided by two 5 kW 48 VAC motors. The flange-mounted helical gearbox as well as the power transmission via chain drive achieve the high traction forces. For optimum power transmission, two 18" solid rubber tires are mounted as drive wheels.

3.5 LIGHTING

The Lighting system Includes:

- Two Headlights
- Two Back Headlights
- Two lights for the Lifting Platform
- Direction Indicators
- Status-LED
- Strobe light (optional)
- Work light (optional)

Please observe the local regulations for lighting. Special adaptations are available if needed.

3.6 BRAKE

In general, the aircraft tug is braked by energy recovery. The motors work like generators and easily feed the batteries with the generated energy. If this deceleration of the pure braking force is not sufficient, an opposite control command can increase the deceleration.

The magnetic brake is activated when the vehicle is at a full stop, on uphill and downhill gradients and drops out as soon as no operation command is given. The brake is released automatically as soon as a new control command is issued.

3.7 NOSE GEAR CRADLE AND LIFTING PLATFORM

The nose wheel mounts via a mechanical gate. The wheel size is adjusted by two, fully adjustable, nose wheel adapters. The entire nose wheel mount is housed in a rotating platform that can rotate 360 degrees, which in turn is mounted on the lifting platform. This can be raised and lowered by means of an electro-mechanical winch to lift the secured nose wheel off the ground.

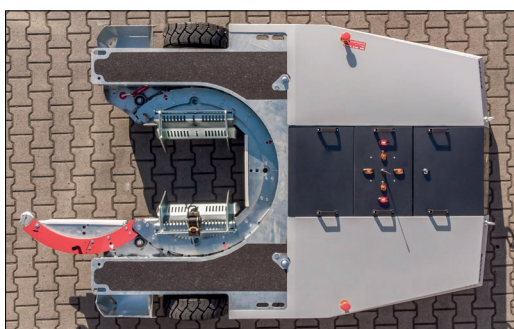

Open Gate

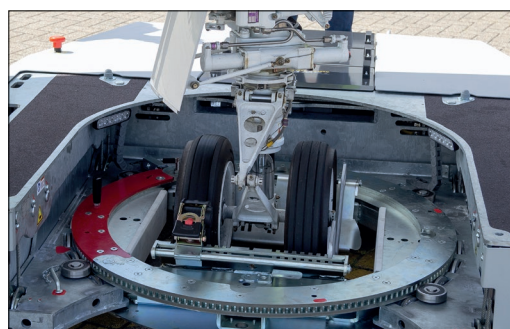

Lifting Platform with Twin Tires

3.8 E-CUBE

All electronic components and controls are housed in a so-called „e-Cube“. This allows easy maintenance and a backup in case of a defect.

The e-Cube can also be exchanged easily to incorporate any new control features, thus forming the heart of the aircraft tugs.



WARNING: The e-Cube is sealed and only accessible to specifically designated TowFLEXX personnel. If the seal is broken without written confirmation or by unqualified personnel, any warranty claim is voided!



The e-Cube is the Heart of the TF5 Aircraft Tug



Programming the individual Functions of the Tug

3.9 CONTROL STATEMENT

The Aircraft Tug in general is controlled by two differentiated driven wheels. Together with two castor wheels in the front of the tug the allows to turn 360 degrees on the spot.

The Indicator Lights of the TF5 always show the direction in which the nose of the tug is moving.

DRIVING MODE: NORMAL

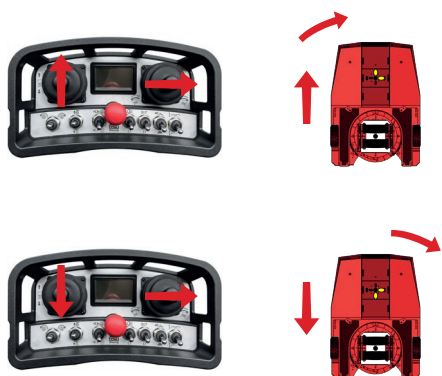

DRIVING MODE: INVERTED



This graphic is just an extract of all the possible control variations.

3.10 WARNINGS AND TYPEPLATES

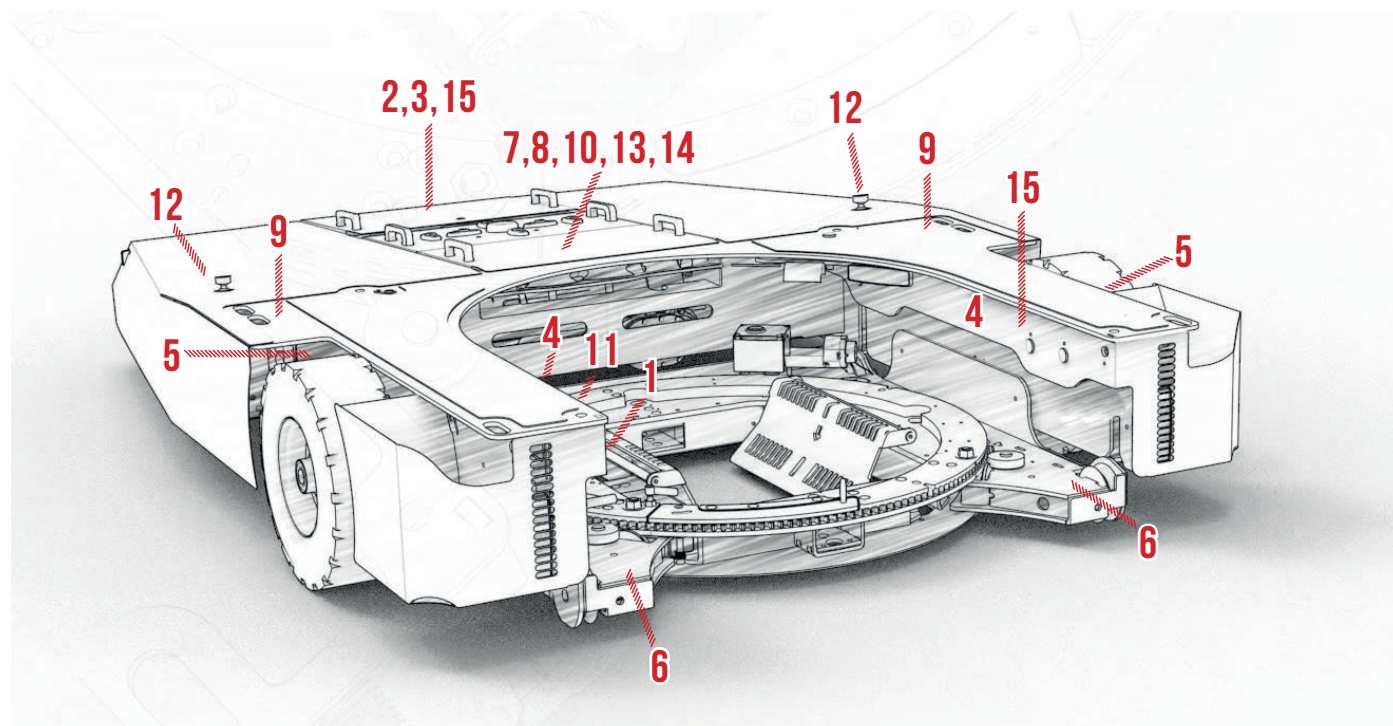

3.11 EC-DECLARATION OF CONFORMITY

MANUFACTURER AND DISTRIBUTING COMPANY

Name: TowFLEXX GmbH
Street: Woestendoellen 95-96
City: D-49429 Visbek
Country: Germany
Phone: +49 (0)4445-988144
E-Mail: info@towflexx.de



Hereby declare that the device described below in the version we have placed on the requirements of the EC Directives listed below. In the event of a change or improper use not agreed with us, this declaration shall be invalid.

DESIGNATION OF THE DEVICE

Towing tractor for aircraft, trailers or other non-self-propelled rolling devices.

Device Type: TowFLEXX TF5 - Aircraft Tug up to 60.000kg towing weight
Identification No.: TF52001XX - ...

APPLIED DIRECTIVES AND STANDARDS

Machinery Directive 2006/42 EG in the last Version, EMC Directive 2004/108 / EC in the latest version for industrial trucks implemented in the harmonized standard EN 12895, Applied standards and specifications: *

DIN EN ISO 12100- (3/2011) Safety of machinery, general principles of design risk - division u.
Risk reduction.



Axel Schickling
Managing Director

*The valid version of the standards / specifications always applies on the day of issue of this declaration.

3.12 MORE CERTIFICATIONS

- EN 292-1
- EN 292-2
- EN 60204-1
- EN 50178
- IEC 801 (2-4)
- ENV 50142
- EN 55011
- EN 50081-2,
- EN 50082-2
- IEC 68-2 (-1, -2, -3, -6, -27)
- EN 60529
- EN 300-220-3 1.1.1
- EC Machinery Directive (89/392/EEC)
- EC Low Voltage Directive (73/23/EEC)
- EC Directive of Electromagnetic Compatibility (89/336/EEC)
- EC Directive R & TTE (99/5/EC)

3.13 SPECIFICATIONS

TOP VIEW

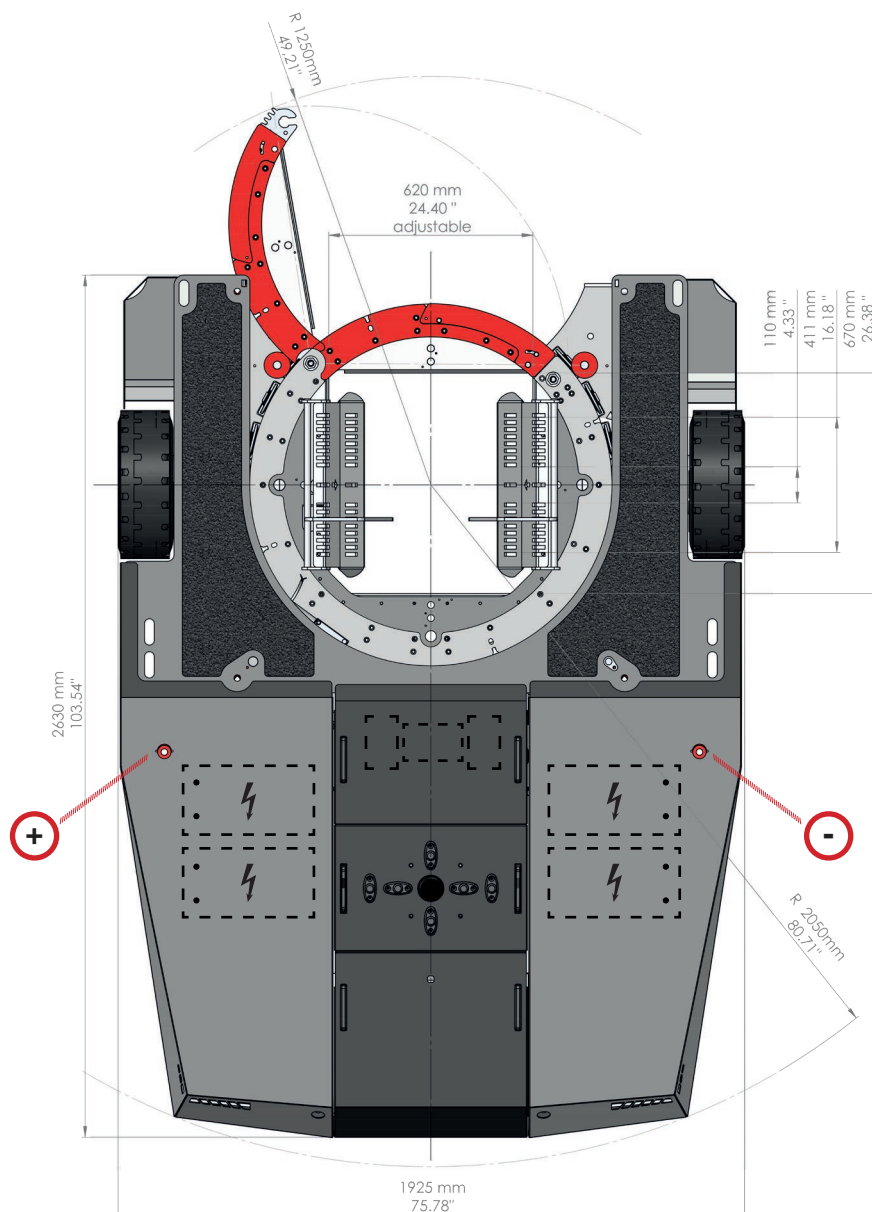

REAR VIEW

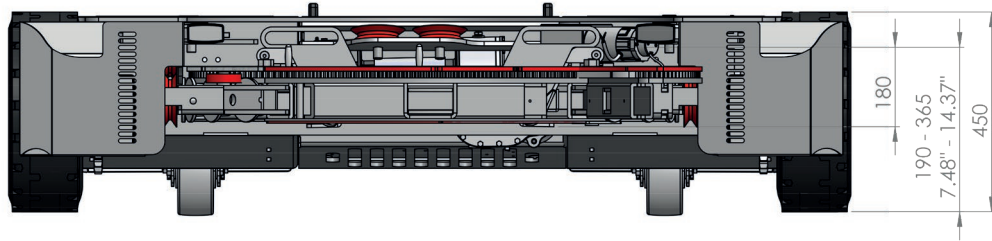

SIDE VIEW

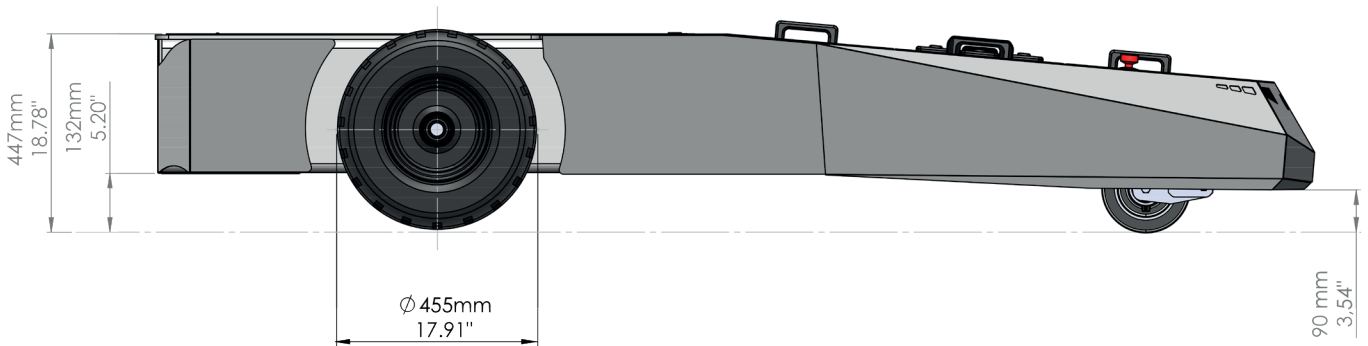

Length	2630 mm (103.54")
Width	1925 mm (75.79")
Height	450 mm (17.72")
Wheelbase	940 mm (37") Support W., 1600 mm (62.99") Drive W.
Ground Clearance	Back: 132 mm (5.20"); Front: 90mm (3,54")
Turning Circle	2.050 mm (80.70")
Height of the Lifting Platform	100 mm (3.94")
Shipping Weight incl. Batteries	1.900 kg (4.189 lbs)
Speed (without Load)	6 km/h (3.83 mi./h)
Speed (loaded)	4 km/h (2.49 mi./h)
Range in km (Miles)	up to 8 km (5 mi.) (depending on the Load; at use in Intervals)
Battery Capacity	3 - 4 days (depending on the Load; at use in Intervals)
Working Temperature	-20°C to +50°C / -4°F to +122°F
Working Humidity	Max. 90% (Relative Humidity)

3.14 REMOTE CONTROL

Frequency Range	see Plate
Baudrate	1.200 - 9.600 Baud (Bit/sec)
Operating Voltage	Battery 7.2V
Power Consumption	0 - 100 mA
RF Performance	< 10 mW ERP
Safety Class	IP 65
Working Temperature	-20°C to +70°C / -4°F to +158°F
Weight (without Battery)	1.000g
Dimensions (L x W x H)	247 x 139 x 117 mm / 9,72" x 5,47" x 4,60"

3.15 POWER SUPPLY

The aircraft tug is supplied with energy exclusively via batteries. The system consists of four 12VDC maintenance-free, sealed lead-gel batteries. The batteries are charged via the integrated charger (100-240VAC connection) (see 4.8 Aircraft Towing Charger, page 30).

3.16 CONNECTIONS

The aircraft tug has various connections. Therefore the operator must be able to identify the connections shown in the figures below:

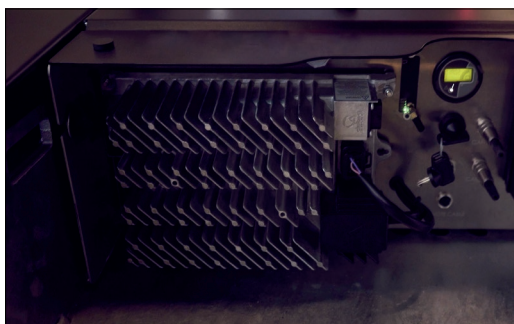

Battery Charger

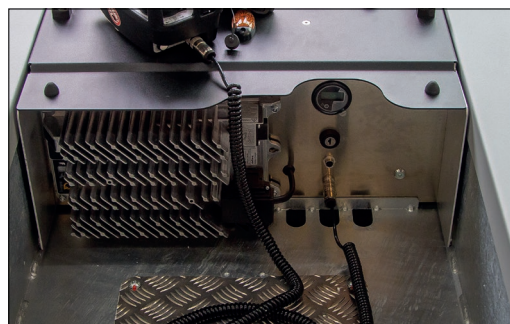

Cable Connection for the Remote Control (optional)

3.17 SUPPLIES

The fluids used in the aircraft are reduced to a minimum, thereby minimizing the risk of leaking:

- Door Latch & Gate: regular high Temperature Chain Grease
- Drive Chain: regular high Temperature Chain Grease

3.18 AMBIENT TEMPERATURE & WORKING ENVIRONMENT

With constant use under extreme temperature changes and condensing air humidity special equipment and approval is required for the aircraft tug.

in order to ensure the best functionality, we recommend to use the equipment at the following temperature range:

-20°C to +50°C / -4°F to +122°F

In order to preserve a long durability of the device and the batteries, store it neither in very cold, nor in very warm outdoors. Working in rain and snow is no problem for the TF5, but even in these weather conditions, we recommend to store the unit in a protected place after use.

3.19 POLLUTION OF THE ENVIRONMENT AND SURROUNDING PERSONNEL

The manufacturer confirms compliance with the limits for electromagnetic interference and immunity, as well as the static electricity discharge test according to EN.



WARNING: Non-ionizing radiation (eg wireless data transmission) may interfere with the functioning of medical devices (pacemakers, hearing aids, etc.) of the operator, as well as persons in the environment, and lead to malfunctions.

It should be clarified with a doctor or the manufacturer of the medical device, whether this can be used in the vicinity of the aircraft tug.

4. OPERATION AND USE

4.1 REMOTE CONTROL

The radio remote control of the aircraft towing vehicle is used to transmit any movement commands and other functions to the aircraft tug. Country-specific security radio is used.

The direction of travel (forward / backward & left / right) is determined via two joysticks. Both can be operated independently of each other. The lower part of the radio remote control contains all additional functions. A display, which can be found between the two joysticks, informs the operator at any time about the status of the aircraft tow tug (i.e. battery & equipment errors etc).

Centrally accessible is an red emergency switch. This immediately interrupts the radio connection and thus the aircraft tug is immediately decelerated to maximum standstill with maximum braking power.



When the EMERGENCY OFF button is pressed while driving, the aircraft tug is decelerated to a standstill with maximum braking power. There is an increased risk of accidents and injuries. If the EMERGENCY OFF is pressed, the error code 1-11 will appear on the display of the remote control.

- **Do not use the EMERGENCY OFF switch as a service brake.**
- **Only use the EMERGENCY OFF button while driving in case of danger.**



When starting the aircraft tug first, all switching elements on the remote control must be in the default position. If this is not the case the unit can not be unlocked via the button on the remote control and the aircraft tug is not ready for operation.



A list of the error codes can be found on page 53 (chapter 10.1).



When starting the unit, a code is displayed on the MDI. This is not an error code, but the current software version.

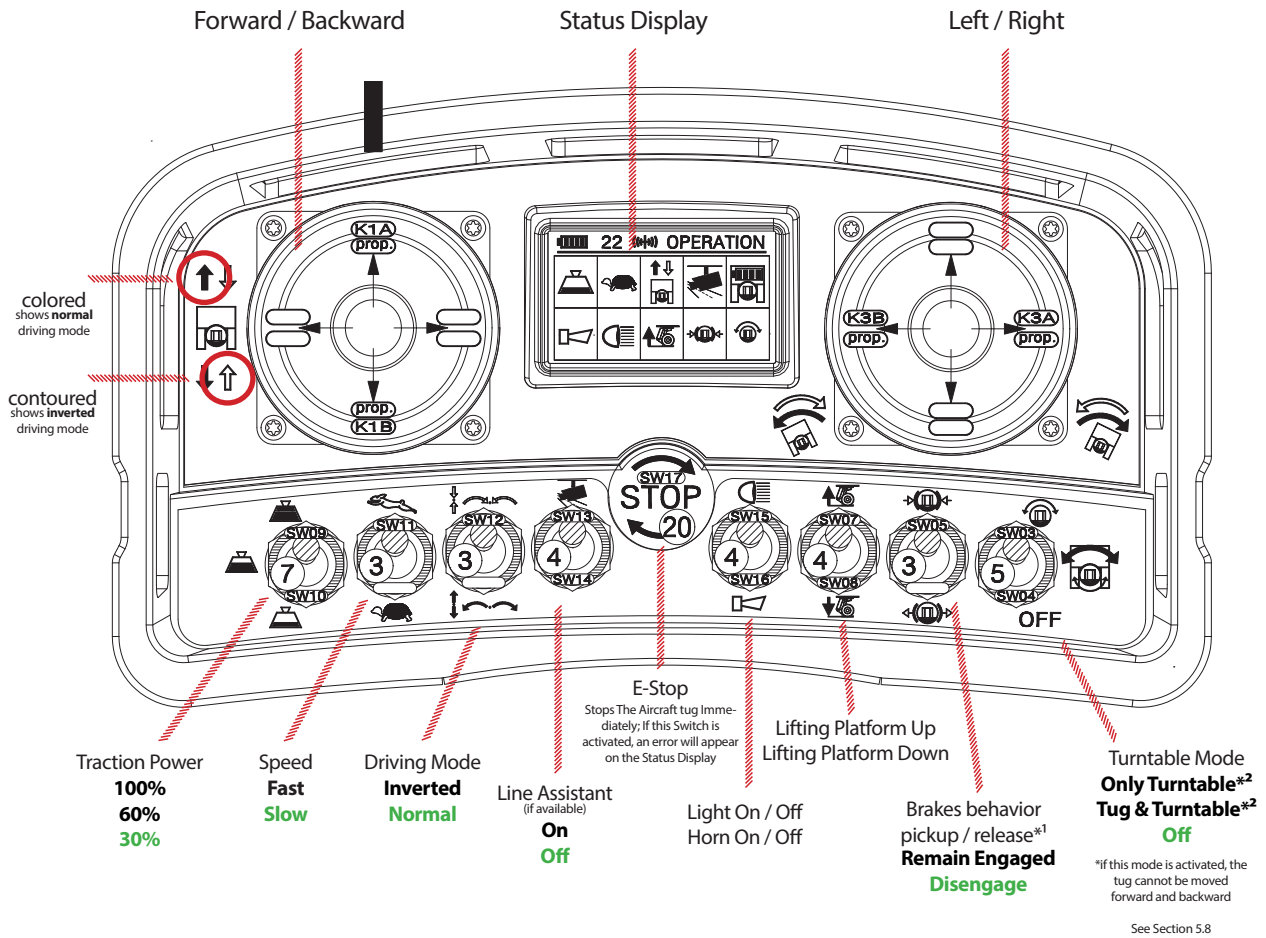

GREEN = Default Position
BLACK = Selection

*2 By default, the TowFLEX TF5 brakes will be released when the platform is lifted or lowered and can move slightly, this allows for movement of the landing gear and will avoid any unnecessary stress to the nose landing gear whilst capturing or unloading the aircraft On ramps or slopes it would be advisable to engage the braking system, so the brakes remain on and locked to prevent the Tug from rolling away when picking up or lowering. (From Software Version 2.3.3 otherwise unassigned)

STATUS DISPLAY

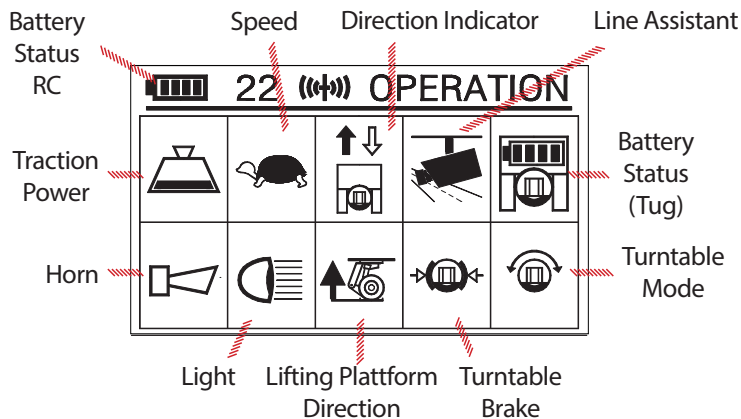

ERRORCODE EXAMPLE

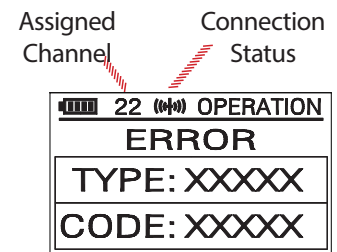

SIDE VIEW RIGHT

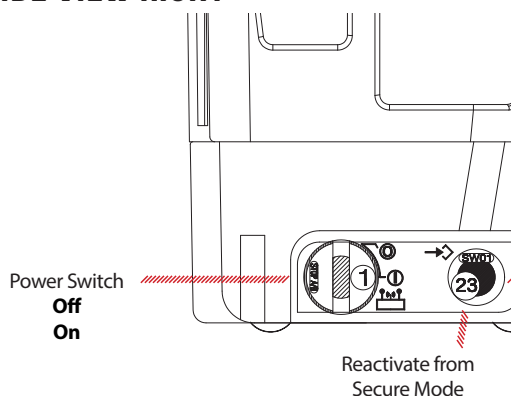

SIDE VIEW LEFT

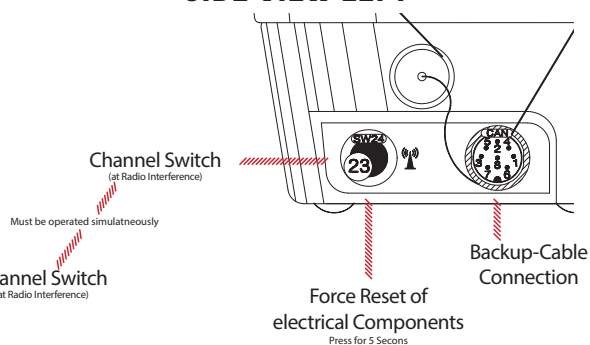

4.2 TURNING THE REMOTE CONTROL ON AND OFF

To turn on the radio transmitter, the side-mounted rotary switch is moved to the corresponding position. This is marked ON or OFF.



Note: *If it is foreseeable that the aircraft tug will not be used for more than 60 seconds, the radio transmitter should always be deactivated immediately.*

4.3 BATTERY CHARGER AND BATTERY OF THE REMOTE CONTROL

The power supply of the remote control is carried out by means of a nickel metal hydride battery. The scope of delivery always includes two batteries.

One of the batteries charges in the front compartment during operation of the aircraft tug. The other battery is intended for operation in the transmitter.



Charger of the RC-Battery

4.4 BATTERY REMOVAL OF THE REMOTE CONTROL

1. Press the orange Lock
2. Slide the battery to the side and remove it

Inserting the Battery is done in reverse order.



Note: *If the transmitter is not used for a long time, the battery must be removed from the transmitter and charged at least every four weeks. This prevents deep discharge and thus damage to the battery.*

4.5 MANUAL CHANNEL CHANGE

The radio remote control has a safety channel feature. This automatically selects a trouble-free channel when switching on. Should there nevertheless be more interruptions in the radio connection, the channel can be changed manually. To do this, press the „Channel change“ buttons on the left and right at the same time. The display then shows the new channel.



ATTENTION: The channel change may only be carried out when the aircraft is at a standstill, otherwise the aircraft tractor will suddenly be braked.

4.6 SAFETY MODE / DEAD-MAN-MODE

If no control pulse is send for 60 seconds, the remote control switches to a Secure Mode. If this is activated, the aircraft tug will not respond to any command. To unlock the remote control again, press the white button on the right side of the remote control („Reactivate from Secure Mode“). If the input is accepted, an audio signal will be given from the unit.

4.7 TURNTABLE GATE AND LOCK

For the nose wheel cradle a gate is incorporated in the turntable of the lifting platform. This allows the aircraft nosewheel to be received (for more details to this process see 5.6 Capturing the Aircraft, Page 34) . Opened and closed, the gate is as follows:



DANGER: An improperly closed turntable door can cause the aircraft to slip out of the cradle while being towed! This is a danger to life! In addition, it is imperative to pay attention to the locking pin engagement of the gate.

OPEN

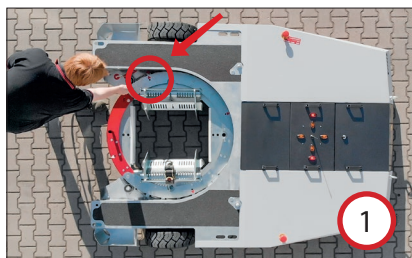

Unlock the Gate

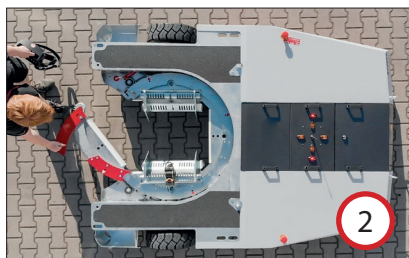

Open the Gate with the Handle

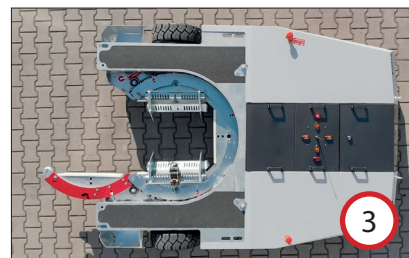

Open the Gate completely

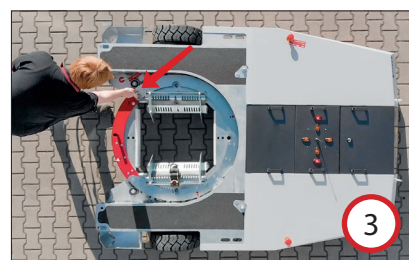
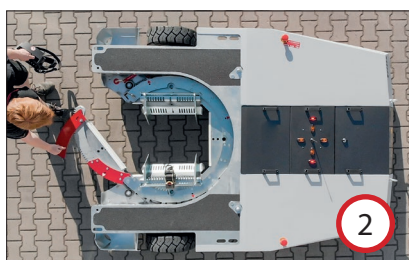
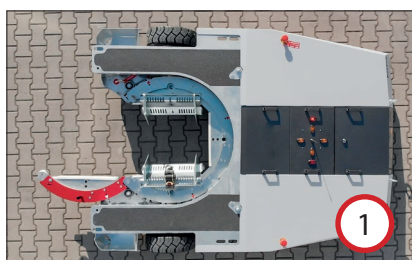



Always make sure the red marked locking pin is locked in correctly to it's final position, after closing the turntable gate.

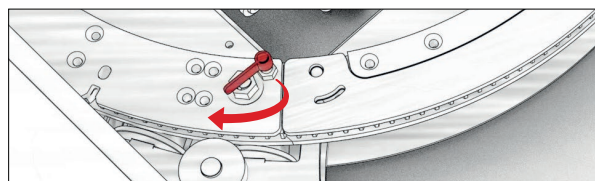

4.8 AIRCRAFT TUG CHARGER

A charger is integrated to charge the aircraft tug. This is located in the front storage compartment (see 3.2 Assemblies and functions, page 16). The supply voltage of the charger is over 100-240 VAC.

To start the charging process, the supply cable, which is located in the front storage compartment, is plugged into an appropriate power supply. Make sure the main key switch of the tug is turned to OFF and BOTH eStops are pulled.

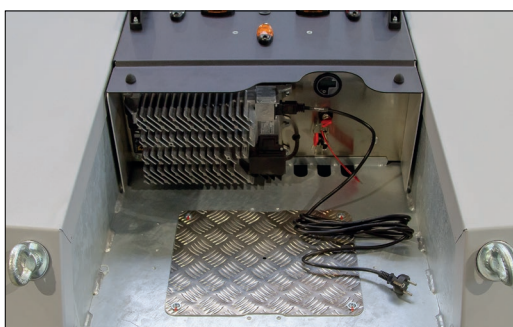

Charger of TF5



Activate Charger: key switch to off, pull BOTH eStops up



WARNING! When charging, the batteries emit a mixture of oxygen and hydrogen (oxyhydrogen gas). Gassing is a chemical process. This gas mixture is highly explosive and must not be ignited.

- Check cable and plug for visible damage before charging.
- Ventilate the room where the aircraft tractor is charging sufficiently.
- There must be no combustible materials within a distance of at least 2 meters of the aircraft tractor parked for charging (unless it has a special certification).
- Always follow the safety regulations.



ATTENTION! If the tug is not being used, make sure that the key switch is turned to the OFF position. Otherwise there is a risk that the batteries will be fully discharged and thus irreparably damaged.



Note: the TF5 has an intelligent charger. The manufacturer recommends charging the tug sufficiently and regularly. It can easily remain connected to the charger for several days, without damaging the batteries.



Solid blue: AC power available



Flashing green: Low state of charge
Solid green: High state of charge



Flashing green: High state of charge
Solid green: Charge complete



Solid Red: Charger fault



Solid Amber: External error condition - caution



Flashing green: USB Port active
Solid green: Safe to remove USB flash drive

4.9 DIRECTION INDICATORS

In the front part of the aircraft tug is a direction indicator which indicates the direction in which the aircraft tug moves depending on the driving mode. The LED indicates the direction before the tug starts to move, the joystick reflects the users input.

4.10 STATUS-LED

Two status LEDs are located directly next to the direction indicator. The left, red LED in the moving direction indicates the operational readiness of the aircraft tug. After the radio connection has been established, this is indicated by the right, white LED in the moving direction. If the aircraft tug is switched off, none of the LEDs is lit.

4.11 MDI DISPLAY

The multifunction display communicates with the drive control and shows the operating hours in normal operation. During the start up, the software version of the drive control is shown in the display saying **EP019** or similar - **THIS IS NO ERROR CODE**

If there is a malfunction in the aircraft tug, this is indicated by the red LED and an error code in the display.

The MDI indicator is located inside the front storage compartment.



Note: When leaving the factory the MDI already shows 4 - 12 operating hours due to production processes and operating tests.

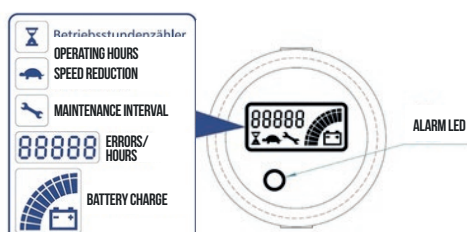

MDI Display

5. TOWFLEXX OPERATION

5.1 SWITCHING THE AIRCRAFT TUG ON AND OFF

In general, the aircraft tug is de-energized via both battery disconnect switches. In addition, to protect against unauthorized access, a key switch is installed. Before starting the unit via key switch, make sure both e-Stops are pulled, otherwise no current is flowing.

SWITCH ON:

1. Turn the key switch to the ON (2) position and then overturn it to position 3 to start the ignition.
2. Pull both battery disconnect switches (e-Stops)

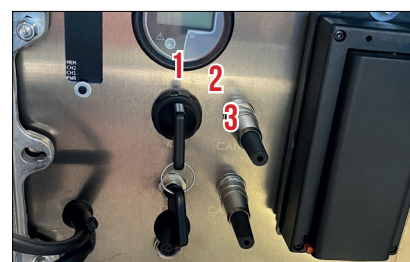

Keyswitch

TURN OFF:



ATTENTION! *If the battery disconnect switch (e-Stop) is activated while driving, the aircraft tug is braked to maximum standstill with maximum braking force. There is an increased risk of accidents, damages and injuries.*

- **Do not use the battery disconnect switches (e-Stop) as a service brake, ONLY in an emergency situation.**



ATTENTION! *Due to a defective or inaccessible battery disconnect switch (e-Stop), there is a risk of accident. In dangerous situations, the operator cannot stop the aircraft tug in time by operating the battery disconnect switch (e-Stop).*

- **The function of the battery disconnect switch (e-Stop) must not be affected by objects.**
- **Immediately notify the supervisor of any detected defects on the battery disconnect switch (e-Stop)**
- **Mark and shut down the defective aircraft tug.**
- **Only put the aircraft tug back into service after locating and repairing the defect.**



ATTENTION! *If the tug is not being used, make sure that the key switch is turned to the OFF position. Otherwise there is a risk that the batteries will be fully discharged and thus irreparably damaged.*

5.2 BATTERY DISCONNECT SWITCH ACTIVATION (EMERGENCY-OFF / E-STOP)

If one of the battery disconnect switches is pressed, all electrical functions are switched off. The aircraft tug is braked to a standstill. An errorcode 1-1 is shown.

5.3 RELEASE BATTERY DISCONNECT SWITCH

If both battery disconnect switches are unlocked by pulling, all electrical functions are switched on. The aircraft tug is ready for use (provided the aircraft tug was ready for operation before operating the battery disconnect switches). Errorcode 1-11 is displayed, as a confirmation, that the e-Stops have been activated.

5.4 TESTS AND ACTIVITIES BEFORE DAILY STARTUP



WARNING! Damage or other defects in the aircraft tug or attachment (optional equipment) can lead to accidents.

If damage or other defects in the aircraft tow tug or attachments (optional equipment) are detected during subsequent inspections, the aircraft tow tug may not be used until it has been properly repaired.

- ***Immediately report detected defects to the supervisor.***
 - ***Mark and immobilize a defective aircraft tug.***
 - ***Only put the aircraft tug back into service after locating and repairing the defect.***
- Check the entire aircraft tug for damages.
 - Check wheels for damage.
 - Visual inspection of the drive chain.
 - Check the steel cable of the winch for overlapping
 - Check directions of travel by remote control.
 - Check markings and plates for completeness and readability (see marking points and nameplates, page 20).
 - Checking the control lights (direction and status LEDs)



DANGER: Check gate pin lock for positive engagement into turntable location. Failure to do so can result in damage to aircraft, injury to personnel or death!



5.5 SET NOSE WHEEL ADAPTER

For a safe working process it is very important to adjust the nose wheel adapters and spacers to the corresponding nose wheel. Various options are available.



ATTENTION! Failure to comply will prevent proper towing operations and may result in damage to the aircraft and the aircraft tug.

The diameter of the mount is adjusted using the nose wheel adapters. To adjust the current setting, unlock the locking mechanism of the nose wheel adapter. Now the adapters can be adjusted in length. It is important to ensure that the lock is only securely locked in the intended manner.

For nose landing gears with single tires, the spacers must be inserted beside the tire. This prevents the nose wheel from turning within the settings.



ATTENTION! When adjusting the nose wheel adapter there is a risk of crushing

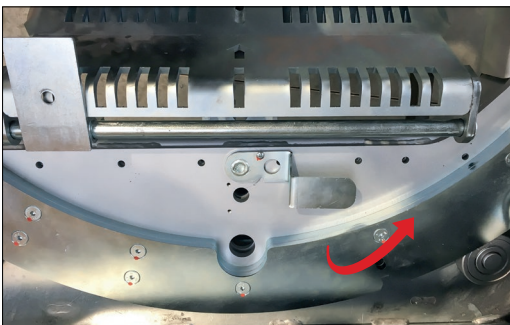

Rotate the lever behind the nosewheel adapter 90 degrees

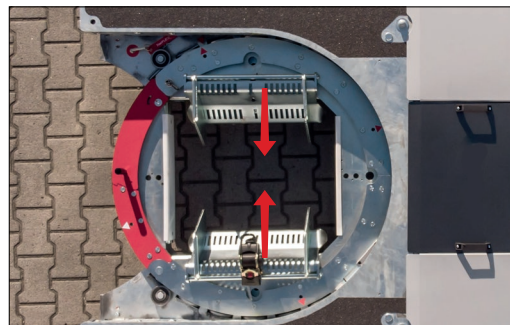

Adjust the Nosewheel Adapter



Scan or Click for Video

5.6 CAPTURING THE AIRCRAFT

When picking up the aircraft with the aircraft tug, the main landing gear of the aircraft must be secured by chocks or by the parking brake.

Set remote control to slow speed (turtle).

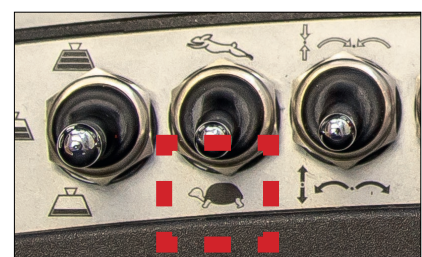

Make sure that there is nothing under the platform! Ensure that the mark on the gate points to the mark on the platform. Then move the lifting platform to the lowest position.

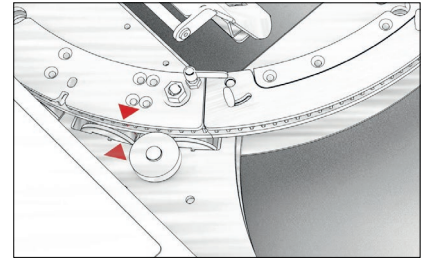

Unlock the gate by turning the lock pin 180°.

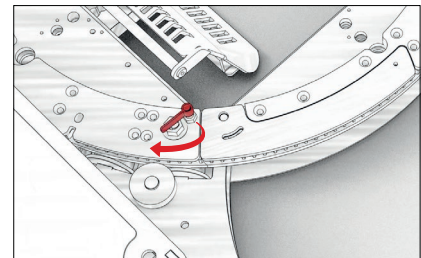

Use the handle to open the gate.

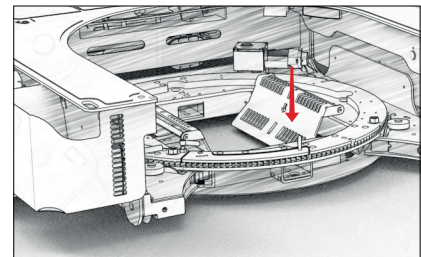

Then the aircraft tug can be driven from the side (or, depending on the configuration, also from the front / rear) under the nose wheel.

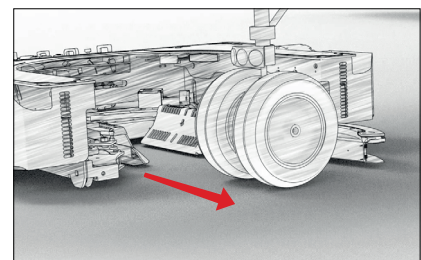

The adapters can be adjusted accordingly for nose wheels of different sizes. For this purpose, the nose wheel spacers are hooked into the mount according to the wheel size. Before picking up the nose wheel, only the two front spacers (in the pick-up direction) are attached, after picking up the two rear spacers will be hung in.

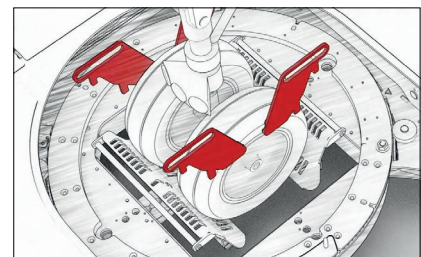

Close and lock the turntable gate.



DANGER! An improperly closed turntable gate can cause the aircraft to slip out of the cradle while towing! This is a risk of injury or death!

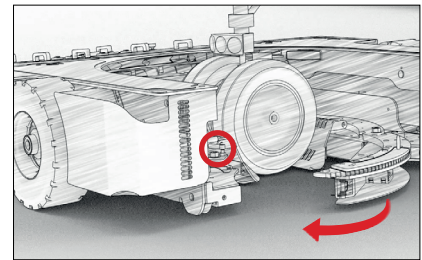

Lift the nosewheel.



ATTENTION! Release the parking brake from the aircraft and remove the chocks in front of the aircraft wheels.

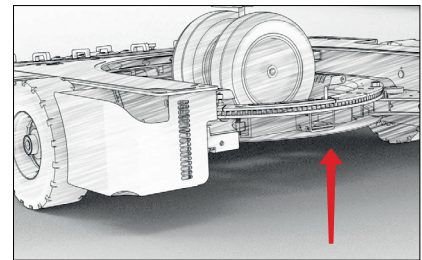

Secure the nose wheel with the help of the safety strap.

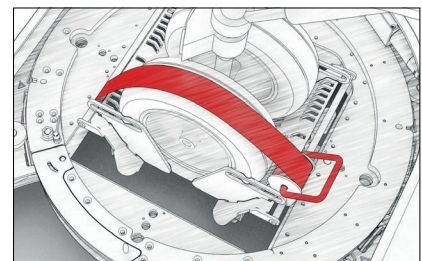

The aircraft tug can now be turned in the direction of travel. After that change the turntable mode to default, to be able to move the tug forward.

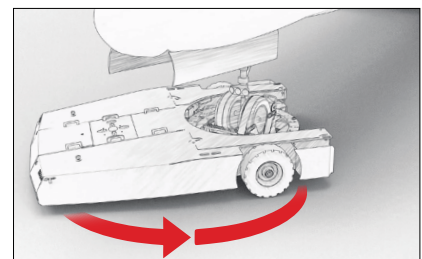

CLICK OR SCAN FOR DETAILED VIDEO

5.7 AIRCRAFT RELEASE

The unloading of the aircraft is carried out in reverse order to the setting. Before unloading, make sure that the aircraft is properly secured. To do this, the chocks on the main landing gear and the aircraft parking brake must be applied.

Release the safety strap (or safety bar) to prevent possible damage to the nose wheel or to the aircraft tug.

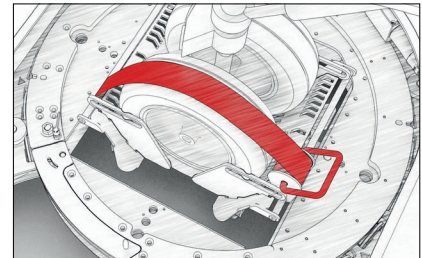

Make sure there is nothing under the platform. Move the lifting platform to the lowest position.

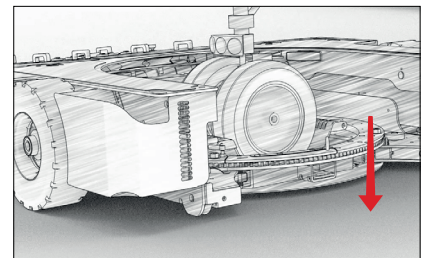

Unlock the gate by turning the lock 180°. Use the handles to open the gate.

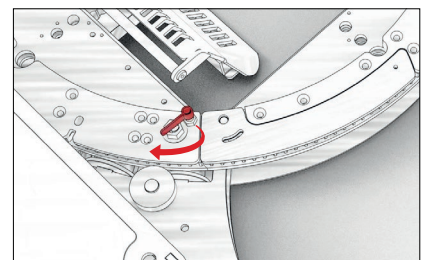

The tug can now be carefully driven out. Once the nosewheel is out of the way, the gate should be closed and the lifting platform raised immediately to prevent damages to the turntable while driving.

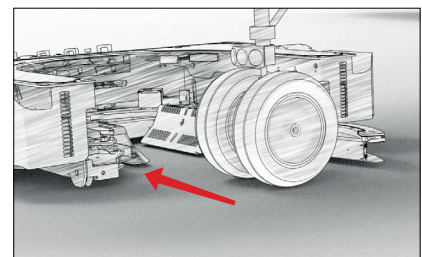

Note: *In order to ensure the longevity of the aircraft tug, longer distances should be avoided with the turntable gate open and with the lifting platform lowered.*



5.8 TURNTABLE MOTOR

The turntable motor enables active control of the turntable. The remote control offers three different control variants, which are described in the following section.



Turntable Motor

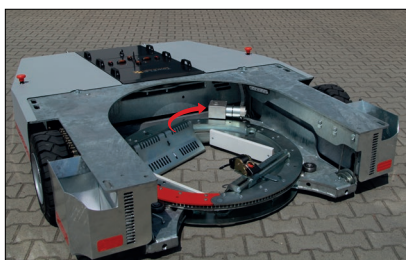

Switch to disengage on the backside

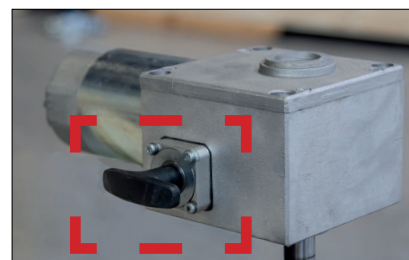

Switch to disengage turntable motor

DISENGAGED MOTOR

A rotary switch on the back of the turntable motor allows it to be disengaged. The turntable moves freely and the nose wheel adjusts itself automatically and mechanically in the direction of travel of the tug. At this point, there is no more control of the turntable motor via the remote control.



ATTENTION! In this control modes, the maximum deflection angle of the nose wheel must be taken into account. This is aircraft-specific and must be monitored by the operator! Failure to comply may result in damage to the aircraft.

COUNTER CONTROL (2)

In this control mode, the turntable is controlled in the opposite direction to the aircraft tug and enables the user to swivel the tug 360° around the nosegear. This mode is only active at standstill.



MANUAL CONTROL (3)

This control mode is used to manually adjust the turntable when standing, without any movement of the aircraft tug. If this mode is active, the turntable turns left or right via the directional joystick. Simultaneous towing is not possible in this mode.



5.9 NOSEWHEEL APPROACH CONFIGURATIONS

The aircraft tug offers four different ways in which the nose wheel of the aircraft can be approached. The illustration below shows you the different options.

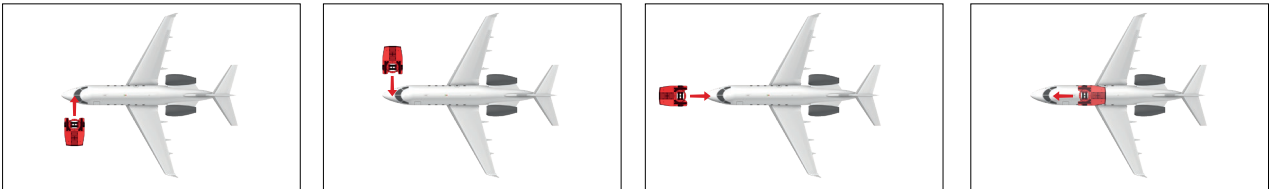

Note: It is important to note that the position of the nose wheel adapters may need to be changed for each configuration.

5.10 TOWING GROUND SUPPORT EQUIPMENT

Optional OEM accessories can also be used to tow ground support equipment with the aircraft tug. For this purpose there is a recess for a locking bolt inside the turntable. Before hauling AGE/ GSE, make sure the turntable is locked. The lifting platform must be brought into the uppermost position against the limit switch.



ATTENTION! Failure to comply may result in damage to the TowFLEX unit.

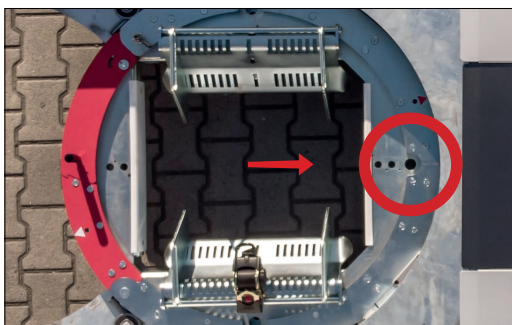

Recess for locking Bolts



Locking for the Turntable

5.11 EMERGENCY RELEASE OF THE WINCH

To lower the lifting platform in the event of a radio remote control failure, it can be manually switched to the power supply. The power supply is plugged behind the e-cube.



ATTENTION: The direct connection of the winch to the power supply bypasses the limit switches. It is essential to ensure that the winch is switched off in sufficient time. Otherwise the steel cable guide may be damaged.



Cover of the Winch

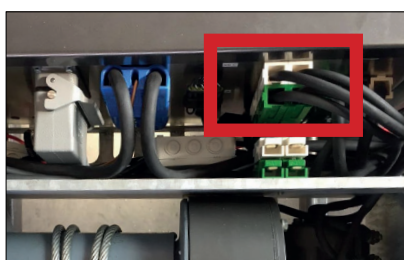

Default Position



Position for the Emergency Release

1. Turn off the aircraft tug by pressing the two battery disconnect switches (e-Stops)
2. Remove the winch cover and the emergency cover underneath.
3. Pull the marked plug and put it in the free position on the opposite side. It is important to pay attention to the correct, colored marking.
4. Now, the winch can be supplied with power via the left battery disconnect switch in the direction of travel. Care must be taken to press the battery disconnect switch (e-Stop) (-) in good time to disconnect the power supply. It is essential to ensure that the emergency disconnect switch is disconnected or the e-Stop is pressed as soon as the turntable is lowered.
5. After the lifting platform has been lowered, the power supply of the winch must be returned to the standard position.



ATTENTION! After this emergency procedure has been carried out, an in-depth inspection of the steel cable is required! If power is not disconnected in time there is a possibility of the cable unwinding!



ATTENTION! Electric hazards are present with the covers removed. This procedure requires special care. Failure to do so may result in personal injury and property damage!



ATTENTION! There is a risk of crushing during this process.



5.12 RELEASING THE MAGNETIC BRAKE

In order to prevent further movement or rolling away in the event of a radio failure or other disturbances on the aircraft tug, the magnetic brake is automatically activated. The brakes can be released manually in the event of a system failure.

Before this emergency procedure is used, the aircraft tug and any towed aircraft should be adequately secured.



DANGER! In case of missing or insufficient securing, unwanted movements may occur on the aircraft tug and on the aircraft!

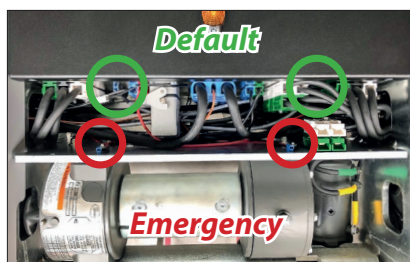

Connector in Default Setting

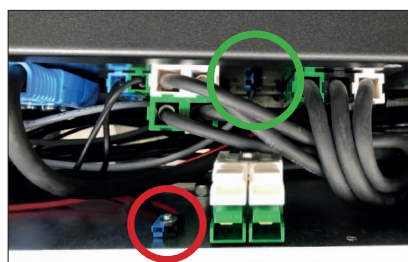

Connector in Default Setting

1. Secure the aircraft tug and aircraft sufficiently!
2. Turn off the aircraft tug by pressing the two battery disconnect switches (e-Stops).
3. Pull the marked plug and put it in the free position underneath.
4. By pulling the two battery disconnect switches, the magnetic brakes are released on both motors. Now the aircraft tug can be moved.
5. It is important to ensure that after completing this emergency procedure, the plug for the magnetic brakes is put back in the default position.



ATTENTION! Electric current flows. This procedure requires special care. Failure to do so may result in personal injury and property damage!



ATTENTION! If the tug requires emergency repositioning do not tow or drag the TowFLEXX unit without following the emergency brake release procedure. Alternatively the tug MUST be repositioned by a capable forklift and forklift operator (page 51)! Failure to comply may result in damage to the equipment.



The following QR code contains a service video for releasing the magnetic brakes:



6. MAINTENANCE



SUPPORT GERMANY / INTERNATIONAL

TowFLEXX GmbH
 Woestendoellen 95-96
 49429 Visbek
 Germany

 +49 4445 988-144
 help@towflexx.com

SUPPORT USA

TowFLEXX Inc.
 4901 Chester Creek Rd
 Brookhaven, PA 19015
 USA

 +1 484 662 3002
 help@towflexx.com



WARNING! Neglecting the regular maintenance can lead to the failure of the aircraft tug and also creates a risk potential for people and operation.



We recommend annual maintenance by TowFLEXX personnel. This includes services that go beyond the checklist. Possible errors that may occur in the future can be detected and corrected prematurely.

6.1 MAINTENANCE SCHEDULE

The operating conditions of an aircraft tug have a considerable influence on the wear of the components. The following maintenance intervals apply to normal operation and use. For special requirements, e.g. excessive dust, strong temperature fluctuations or multi-shift operation, the intervals must be correspondingly shorter and adjusted accordingly.

Maintenance and repair work exceeding the works specified in the maintenance schedule may only be performed by personnel certified by TowFLEXX and after explicit written confirmation. Failure to do so will void the warranty.

The following maintenance checklist specifies the activities to be performed and the time of performance.

Assembly	Persevering Activities	Interval
Batteries	<ul style="list-style-type: none"> min. 1 recharge a Month Check the Battery-Plug for Damage, Function and tight Fit 	10h or monthly 25h or annually
Lighting	<ul style="list-style-type: none"> Lighting function Check 	50h or annually
Tires	<ul style="list-style-type: none"> Check Drive Wheels for Wear and Damage Tighten the Wheel Nuts of the Drive Wheels (220Nm) Check Castor Wheels on Wear and Damages 	50h or annually 25h or half-yearly 50h or annually
Turntable	<ul style="list-style-type: none"> Lubricate wheel flange rollers Check Turntable Gate Function, adjust if necessary Apply Grease on the Turntable Gate Visual inspection Turntable Motor and Gear 	25h or half-yearly 25h or half-yearly 25h or half-yearly 25h or half-yearly
Lifting Platform	<ul style="list-style-type: none"> Visual Inspection and Function Check Check Steel Cable and Grease if necessary Check if the steel cable is still correctly winded on the winch drum 	25h or annually 10h or every 3 month 10h or monthly
Drive Chain	<ul style="list-style-type: none"> Lubricate Drive chain Visual Inspection and Tension Check 	25h or half-yearly 50h or annually
Frame and Chassis	<ul style="list-style-type: none"> Visual Inspection Check Screws for tight Fit Check Readability and Quality of Labels 	25h or annually 25h or annually 25h or annually
Funcional Tests	<ul style="list-style-type: none"> Testing all Commands on the Remote Control Driving Control Testing the Brakes without Load 	25h or half-yearly 25h or annually 25h or annually
Limiters Switch (if installed)	<ul style="list-style-type: none"> Check if it triggers correctly 	25h or half-yearly

6.2 PLAN OF FUSES

Designation	Amperage	Assigned to	Responsible for
F1	350A	Control Unit U1	Drive Motor 1
F2	350A	Control Unit U2	Drive Motor 2
F3	10A	Key Switch DC-DC Converter	Ignition Switch Current Transformer 48V/24V
F5	10A	Supply Auxiliary	
F6	10A	Battery Charger	RC Replacement Battery
F7	3A	CAN Controller	
F8	10A	CAN Controller	
F9	10A	CAN Controller	
F10	250A	Control Unit U6	Turntable Motor

7. REPAIR AND OVERHAUL

7.1 GENERAL INFORMATION

Repairs or overhauls may only be carried out by personnel trained and certified by TowFLEX. In order to ensure reliable operation of the aircraft tug use only certified and original parts from the manufacturer. Neglecting to do so will void the warranty.



WARNING! All modifications to the aircraft tug - especially to the safety equipment - are strictly forbidden!

7.2 REQUIREMENTS FOR THE STORAGE ROOM

If the aircraft tug shut down for more than a month, storage is only allowed in a frost-free and dry environment. Perform actions before, during and after the decommissioning as described.

7.3 ACTIONS BEFORE AND DURING SHUT DOWN

- Clean the aircraft tug carefully
- Apply a light oil on all non-painted or galvanised parts, or cover them with a greasy film
- Charge Batteries (see 4.8 Aircraft Tug Charger; Page 30).
 - the batteries must be charged once a month to avoid damage
- See 7.4

7.4 REQUIRED ACTIONS DURING DECOMMISSIONING



Note: Due to self-discharge of the batteries a possible deep-discharge may happen. Deep-discharges shorten the lifespan of the batteries substantially. To prevent a deep-discharge, recharge the batteries at least once a month.

7.5 RE-COMMISSIONING THE AIRCRAFT TUG

- Clean the aircraft tug carefully
- Charge the batteries
- Maintain the tug in accordance to the maintenance schedule (Page 43)

7.6 WORK ON THE ELECTRONICS

Working at the electric systems is only allowed in de-energised condition. The capacitors in the control system must be fully discharged, this process takes about 10 minutes. Before start working at the electrical systems:

- Only personnel trained and certified by TowFLEXX is allowed to do these work
- Before starting work, make sure that all precautions have been taken to avoid electrical accidents.
- Park the aircraft tug in a secured area.
- Pull the battery connectors
- Take off ring, bracelets, watches and other jewelry



ATTENTION! Electric current flows. This procedure requires special care. Failure to do so may result in personal injury and property damage!

7.7 BATTERY REPLACEMENT

Only personnel trained and certified by TowFLEXX is allowed to do these work.

In case of a defect the batteries can be exchanged in just a few steps:

1. Remove the eyebolts in front of the aircraft tug.
2. Pull the side-covers about 50mm to the front.
3. Open the covers sideways. Take care that the cables underneath the cover do not get too much tension.
4. Take off the black caps of the battery connectors and store them safely
5. Remove the battery connectors and jumpers. Take care to not cause a short in any case.
6. Loosen the stud holding the battery in place.
7. Use the handles on the battery to pull it out.
8. Insert the new battery. (Only use parts that are certified by the manufacturer!).
9. Do steps 1-5 in reverse order. Ensure that the correct polarity is used! Otherwise irreversible damage may be caused.



ATTENTION! Make sure to not forget to reinstall the black battery caps to the battery connectors. Otherwise it is possible to cause a short circuit in the batteries.



Tip: We recommend to use a 13mm metric wrench to exchange the batteries.



Tip: To exchange the batteries, we recommend to get help of a second person.

7.8 E-CUBE REPLACEMENT

The e-Cube of the TowFLEX TF5 can be exchanged very quickly. This can happen in case of technical problems or when updating the electronic components (new security features, additions, etc.).

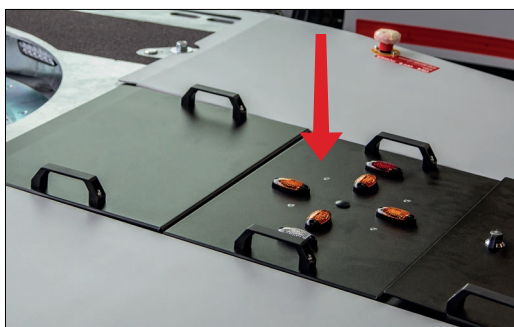

Position of the e-Cube



Just a few steps are needed to remove the e-Cube

1. Push both battery disconnect switches (e-Stops) and secure the tug against unintended movement.
2. Remove the winch cover.
3. Disconnect all connections to the e-Cube. For safety reasons, start with the main power supply (blue connector).
4. Now the e-Cube can be pulled out.
5. Do steps 1-3 in reverse order.



Tip: We recommend that you perform this step with at least two people.

7.9 TURNTABLE GATE REALIGNMENT

It is possible that the gate will lose its correct alignment after a certain period of use. With these easy to follow steps it can be realigned within minutes.

Loosen the four bolts on the lower right side of the turntable.

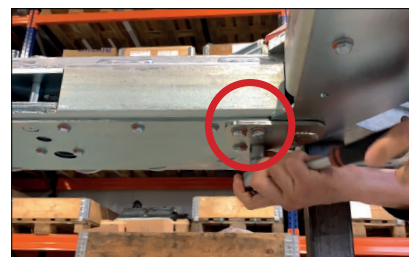



Lift the gate and fix the position with a tool/object of your choice to keep the gate in a slightly elevated position.



Retighten the screws that were previously loosened.

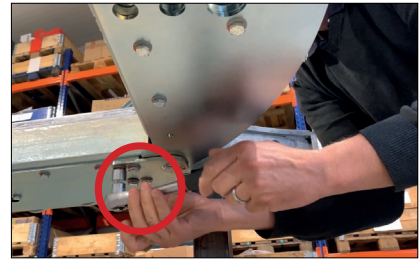

The door should now be aligned again and close smoothly. If this is not the case, try the same procedure by lifting the gate a little bit more or less.



7.10 STEEL CABLE REALIGNMENT

In the unlikely event that the steel cable is twisted, it can be realigned within minutes with these easy to follow steps.

Open the winch cover and check if the steel cable overlaps at any point. If this is similar to the picture on the right, follow the next simple steps to realign it.

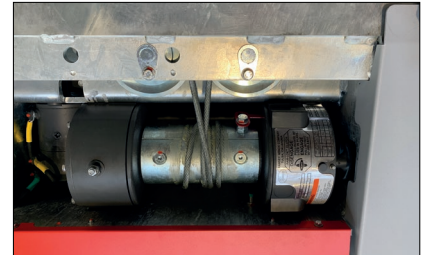

Place an object under the turntable platform (it could be chocks, the nose wheel adapters of the units or a pallet jack) so that the platform lowers and rests on it. This will release the tension of the steel cable on the winch drum.



Once the tension of the steel cable is released, you can bring the steel cable back to its original position with a screwdriver or similar tool. Then hold it in position and move the turntable platform back to the upper position using the remote control. On the way up, the steel cable will regain its tension.

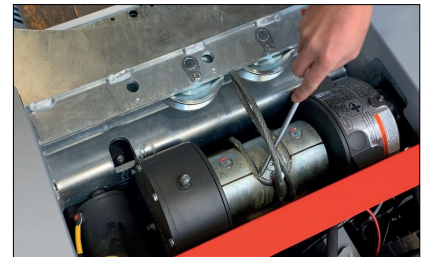

After this procedure the steel cable should run perfectly on the winch drum again. This check should be carried out at regular intervals, which can be found in the maintenance schedule.

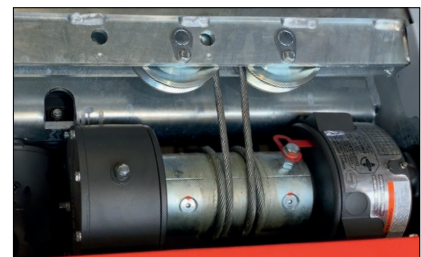

8. PACKAGING AND TRANSPORT

8.1 UNLOADING THE AIRCRAFT TUG

In order to provide the best possible protection for the aircraft tug during transport, it is secured in a reusable wooden transport box. The following steps are necessary to safely drive the tug out of the transport box.

To remove the cover, you must loosen the marked bolts around the cover.



Note: Use the supplied bit to remove the bolts.



Before you can lift the cover and open the flight case, remove the screws on the front panel.



Afterwards the panel / ramp can be folded down.



Lift up the cover and put it aside.



ATTENTION! We recommend to do this with two persons, otherwise there is a risk of injury.



Unscrew the crossbars from both sides.



Take off the crossbars



ATTENTION! We recommend that this step be carried out by two persons to prevent the cross bars from falling onto the tug when removing them.



Unwrap the aircraft tug.



Each of the castors at the front is additionally secured with a wooden panel which must be removed.



Remove the two straps at the front.



The straps on the front side are attached to eye bolts which are mounted in the wooden box. These must be removed in any case to prevent damage when driving the tug out.



WARNING! Failure to follow this step will most likely result in damage for which the manufacturer is not responsible!



Loose the straps at the back.

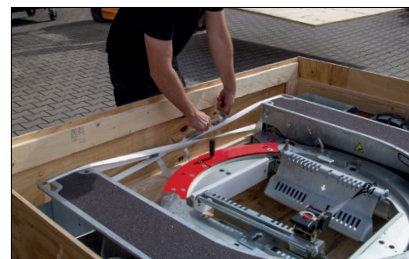

Now the TF5 is ready to be moved out. Make sure that there are no harmful obstacles (like half loosened bolts or similar). Start the unit (pull both E-Stops and activate the bowl switch in the front compartment) and turn on the remote control with the rotary switch on the right side.

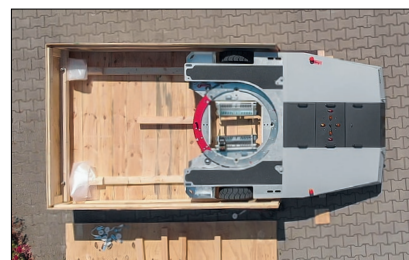

To be able to move the unit, deactivate the dead man function by pressing the white button on the right side of the radio remote control. Make sure all other switches are in default position, otherwise the tug will not move!



WARNING! Please only use forklift trucks with sufficient lifting capacity and fork length for transporting the box. The crate has the following specifications:

Weight: 2.060kg (4.542lbs)

Dimensions: 2930mm (115,35") x 2090mm (82,28") x 670mm (26,38")



ATTENTION! Pick up the crate only from the front side (front ramp)



ATTENTION! If you are not familiar with using TowFLEXX equipment do only remove the unit out of the crate when a TowFLEXX employee is present. Failure to do so can cause irreversible damage to the unit or personal injury.



Note: Before driving the aircraft tug for the first time, the operator should be thoroughly familiar with the handling and have read the entire operating manual.



Tip: We recommend using a battery drill for unloading.

8.2 TRANSPORT WITHOUT CRATE

If you are transporting the aircraft tug without a transport box, there are several options available to you. The aircraft tug can be lifted by crane via the four / six attachment points.

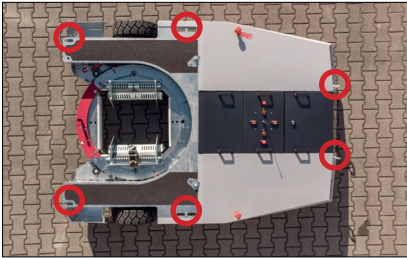

Attachment Points



Crane Safety Hook

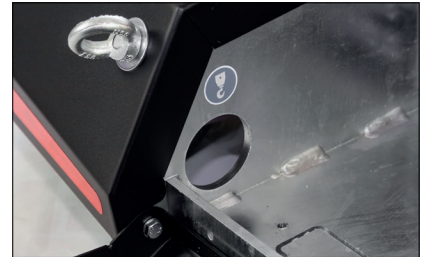

Additional Attachment Point in the Front

Additionally, after releasing the magnetic brake, the aircraft tug can be towed via the two eyebolts at the front (see 5.12 Releasing the magnetic brake).



WARNING! The eyebolts on the front of the aircraft tug are not designed to support the entire weight of the unit. They serve only as auxiliary hooks to move the tug in case of a defect or as guide hooks to prevent the tug from tipping over the front during a lifting maneuver with a crane.

9. DISPOSAL

The final and proper decommissioning or disposal of the aircraft tug must be carried out in accordance with the legal provisions of the country where the tug is used. In particular, the regulations for the disposal of the batteries, the device and the electronics must be observed.

Dismantling of the aircraft tug may only be carried out by trained persons in accordance with the procedure specified by the manufacturer.

10. APPENDIX

10.1 ERROR CODES

The TF5 has various safety features that help to prevent damages or injuries in emergency situations. Whenever one of these features is activated the user gets a notification on the screen of the remote control showing an error code. The following list shows the most common codes that can appear in everyday use.

Code	Explanation
04 - 42	No SPS present, Internal Error Code of Drive Systems
04 - 60	No SPS present, Internal Error Code of Drive Systems
04 - 96	No SPS present, Internal Error Code of Drive Systems
04 - C9	No SPS present, Internal Error Code of Drive Systems
16 - 06	No SPS present, Internal Error Code of Drive Systems
1 - 1	Emergency Stop pressed
1 - 2	Remote control not in neutral state
1 - 3	No connection to Remote Control Receiver/Transmitter
1 - 5	Joystick Error K1A/B
1 - 6	Joystick Error K3A/B
1 - 7	Emergency Stop Error
1 - 11	Release of Emergency Stop acknowledged
1 - 12	External Emergency Stop (only on units with EE-Certification)
1 - 20	Recharging: No Movement possible
2 - 8	No CAN Bus Signal ACE2 2 μ Master Motor right
2 - 9	No CAN Bus Signal ACE2 2 μ Slave Motor right
2 - 10	No CAN Bus Signal ACE2 2 μ Master Motor left
2 - 11	No CAN Bus Signal ACE2 2 μ Slave Motor left
2 - 16	No CAN Bus Signal Remote Control Receiver
2 - 24	No CAN Bus Signal ACE2 Combi 2 μ Master
2 - 25	No CAN Bus Signal ACE2 Combi 2 μ Slave
3 - 1	SPS: Voltage low
3 - 2	SPS: Voltage low
3 - 3	SPS: Voltage low
3 - 4	SPS: Voltage low
3 - 10	Turntable Sync: Difference between Drive and Turntable to high
3 - 11	Turntable Sync: Encoder wrong Direction
3 - 12	Turntable Sync: Unreliable state
3 - 13	Turntable Sync: Target value to high
3 - 14	Turntable Sync: Parameter Error
3 - 22	Temperature Motor right 20°C over Limit
3 - 23	Temperature Drive System right 5°C over Limit
3 - 24	No Feedback Brake right
3 - 25	No Feedback Motor Encoder right
3 - 26	Temperature Motor left 20°C over Limit
3 - 27	Temperature Drive System left 5°C over Limit
3 - 28	No Feedback Brake left
3 - 29	No Feedback Motor Encoder left

Code	Explanation
3 - 30	Temperature Drive System Turntable/Winch 5°C over Limit
4 - 1	Battery Voltage below Limit
4 - 2	Battery Voltage of Remote Control below Limit
4 - 22	Temperature Motor right over Limit
4 - 23	Temperature Drive System right over Limit
4 - 26	Temperature Motor left over Limit
4 - 27	Temperature Drive System left over Limit
4 - 30	Temperature Drive System Turntable/Winch over Limit
8 - xx	Internal Error Codes for Drive System right
10 - xx	Internal Error Codes for Drive System left



TRAINING CERTIFICATE

The training certificate is an internal document certifying that a skilled use of the TowFLEXX TF5 has been instructed.

Hereby we confirm that (Name) _____ employed by _____ completed and passed a successful training with subsequent acceptance.

(Name) _____ is now qualified for the following tasks with the TowFLEXX TF5:

- Pick-up and handling of aircraft
- Training of other colleagues

Both the trainer and the trainee confirm that a professional and complete instruction of the functions as well as the dangers in dealing with the TowFLEXX TF5 were addressed and understood.

Date, Internal Trainer

Date, Internal Trainee





TOWFLEX
Aircraft Tugs

TOWFLEX TF5 - UP TO 60.000KG / 132.000LBS MTOW

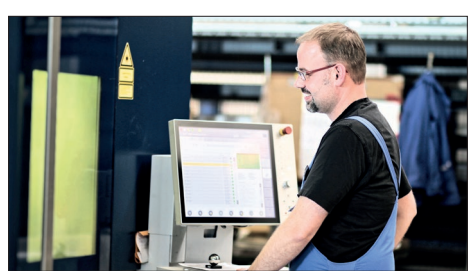

WWW.TOWFLEXX.DE 

 WWW.TOWFLEXX.COM